



Cambridge IGCSE™

CANDIDATE
NAME

--

CENTRE
NUMBER

--	--	--	--	--

CANDIDATE
NUMBER

--	--	--	--

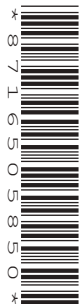

PHYSICS

0625/43

Paper 4 Theory (Extended)

October/November 2022

1 hour 15 minutes

You must answer on the question paper.

No additional materials are needed.

INSTRUCTIONS

- Answer **all** questions.
- Use a black or dark blue pen. You may use an HB pencil for any diagrams or graphs.
- Write your name, centre number and candidate number in the boxes at the top of the page.
- Write your answer to each question in the space provided.
- Do **not** use an erasable pen or correction fluid.
- Do **not** write on any bar codes.
- You may use a calculator.
- You should show all your working and use appropriate units.
- Take the weight of 1.0 kg to be 10 N (acceleration of free fall = 10 m/s^2).

INFORMATION

- The total mark for this paper is 80.
- The number of marks for each question or part question is shown in brackets [].

This document has **16** pages.

- 1 An aeroplane accelerates along a horizontal runway before take-off. The aeroplane accelerates for 35 s. The speed of the aeroplane when it takes off is 72 m/s.

Fig. 1.1 shows how the speed of the aeroplane varies between time $t = 0$ and $t = 35$ s.

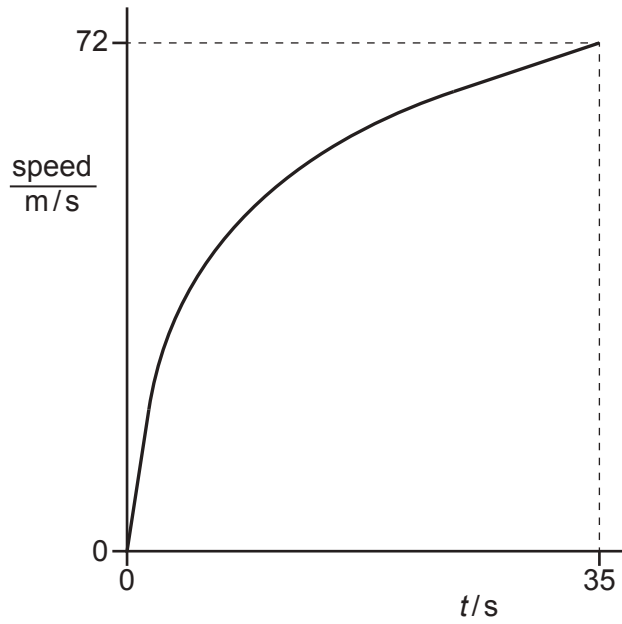

Fig. 1.1

- (a) Define acceleration.

.....
 [1]

- (b) (i) Calculate the average acceleration of the aeroplane between $t = 0$ and $t = 35$ s.

acceleration = [1]

- (ii) The combined mass of the aeroplane, its passengers and its fuel on take-off is 1.1×10^5 kg.

Calculate the average resultant force on the aeroplane between $t = 0$ and $t = 35$ s.

force = [2]

- (iii) The force provided by the engines of the aeroplane is constant.

Give **one** possible explanation for the change in acceleration of the aeroplane between $t = 0$ and $t = 35$ s.

.....
..... [1]

- (iv) On Fig. 1.2, sketch a graph to show how the acceleration of the aircraft varies between $t = 0$ and $t = 35$ s.

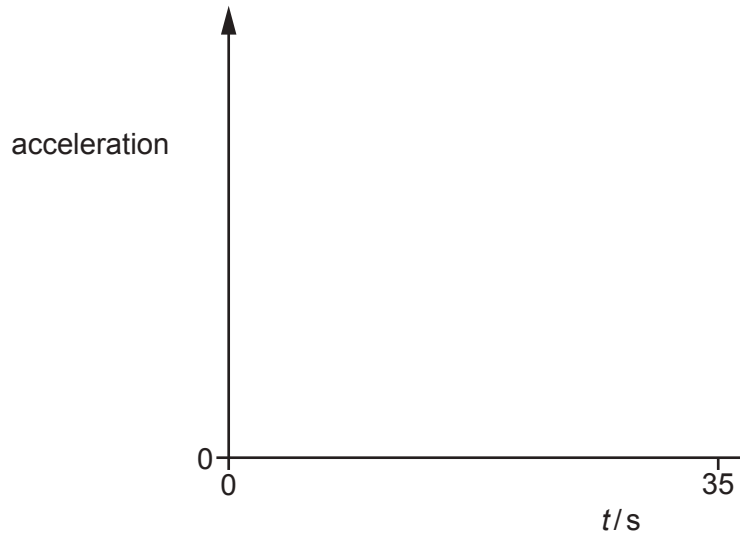

Fig. 1.2

[3]

[Total: 8]

- 2 Fig. 2.1 shows a tennis ball approaching a tennis racket.

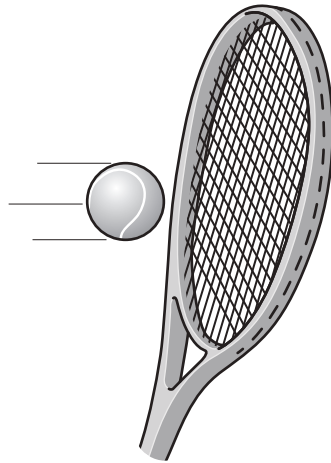

Fig. 2.1

The tennis ball hits the racket at a speed of 52 m/s. The average force on the ball during the time that it is in contact with the racket is 350 N. The speed of the ball after it leaves the racket is 26 m/s in the opposite direction to the initial speed of the ball. The mass of the ball is 58 g.

- (a) (i) Calculate the change in momentum of the ball while it is in contact with the racket.

change in momentum = [3]

- (ii) State an equation which defines impulse in terms of force and time.

..... [1]

- (iii) Calculate the time that the racket is in contact with the ball.

time = [2]

- (b) Calculate the difference between the values of the kinetic energy of the ball before and after the impact with the racket.

difference in kinetic energy = [3]

[Total: 9]

- 3 Fig. 3.1 shows the cross-section of a barrage built across a tidal bay. The barrage is part of a tidal power station.

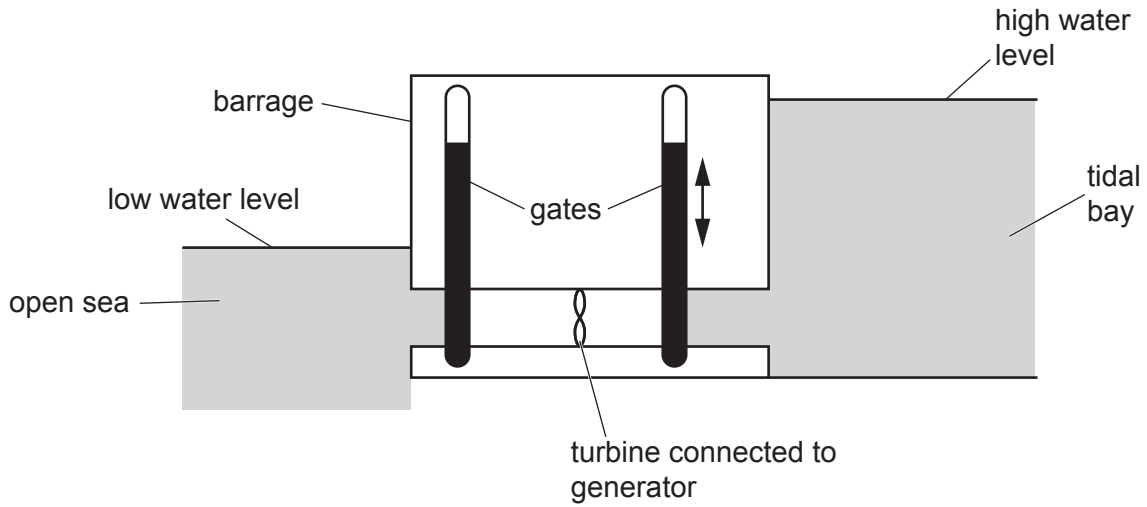

Fig. 3.1

The gates are raised to be open when the tide comes in. The gates are lowered to close when it is high tide. Fig. 3.1 shows the water levels in the open sea and the tidal bay when it is low tide. The gates are raised and water flows through the turbine.

- (a) Complete the sentences to describe the energy transfers which take place when the gates are opened.

Use words from the list.

- | | | | |
|------------------|-----------------|--------------|--------------------------------|
| tidal bay | kinetic | gates | gravitational potential |
| open sea | turbines | water | |

..... energy of the in the
 is transferred to energy in the
 rotating This energy is used in the generator to produce
 electrical power. [3]

- (b) State **one** advantage and **one** disadvantage of tidal power as an energy resource.

advantage

disadvantage [2]

- (c) State the **main** source of energy for tidal energy.

..... [1]

[Total: 6]

- 4 (a) Fig. 4.1 shows a liquid-in-glass thermometer labelled thermometer X.

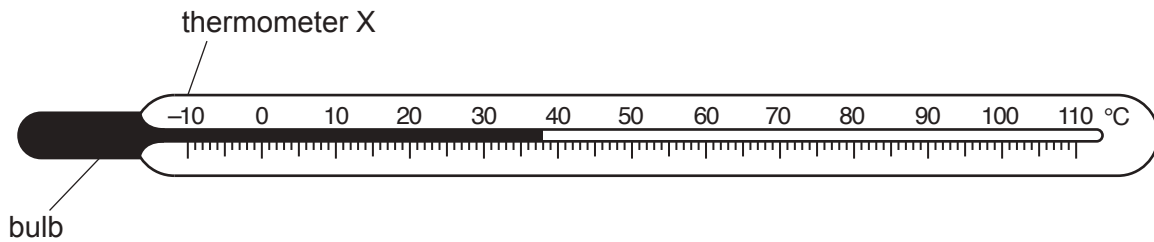

Fig. 4.1

- (i) State the physical property which varies with temperature in a liquid-in-glass thermometer.

..... [1]

- (ii) Thermometer Y has a bulb that contains twice the volume of liquid compared to thermometer X.

State and explain how the sensitivity of thermometer Y compares with the sensitivity of thermometer X.

statement

explanation

..... [2]

- (iii) State and explain **one** change that can be made to the design of thermometer X to increase its range.

statement

explanation

[2]

- (b) A liquid-in-glass thermometer cannot measure a temperature of 1300 °C.

State a physical property which varies with temperature in a thermometer which can measure a temperature of 1300 °C.

..... [1]

[Total: 6]

5 (a) Three identical dishes, A, B and C, contain an equal volume of water.

Dish A is outside in sunlight and experiences no wind during the day. Dish B is outside in sunlight and experiences a strong wind during the day. Dish C is in a dark room.

Water evaporates from each dish. After 12 hours, a student measures the volume of water in each dish. Dish C contains the largest volume of water and dish B contains the smallest volume of water.

Explain, in terms of particles, why the three dishes have different volumes of water.

.....

.....

.....

.....

.....

.....

.....

.....

.....

..... [4]

(b) Define specific latent heat of vaporisation.

.....

.....

..... [2]

(c) Fig. 5.1 shows an insulating beaker, crushed ice, an immersion heater and a thermometer.

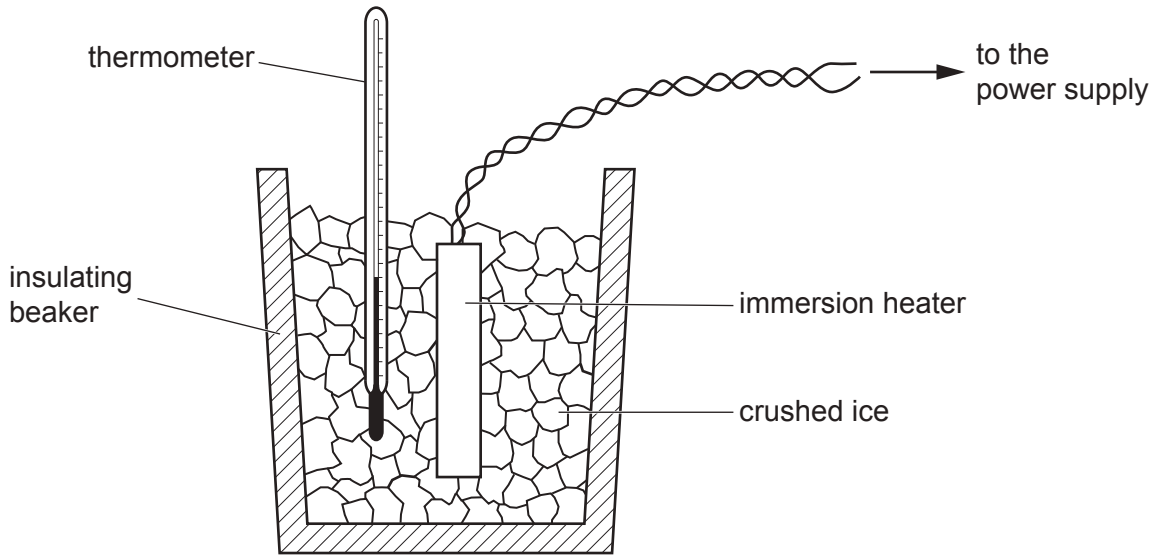

Fig. 5.1

The initial temperature of the ice is -60°C .

The immersion heater is switched on and the temperature is recorded at equal intervals of time.

Fig. 5.2 shows the temperature–time graph.

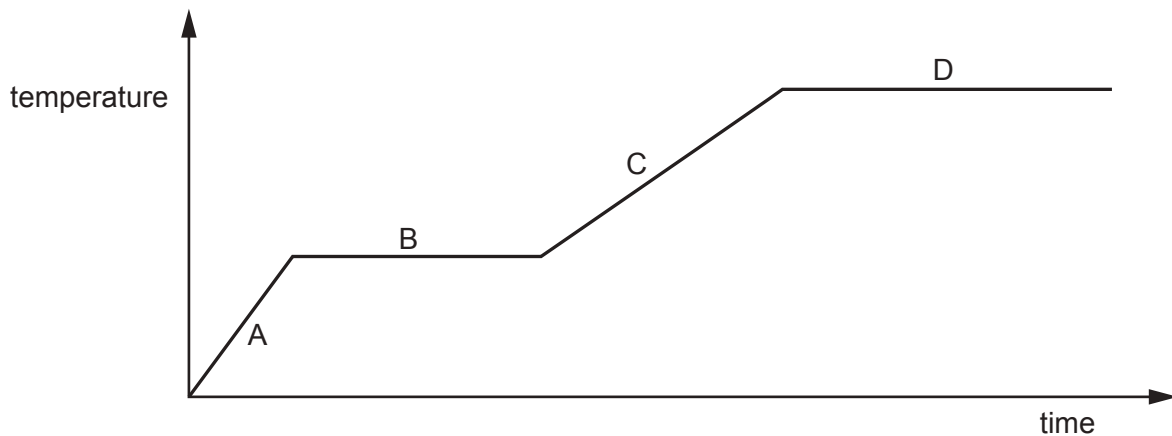

Fig. 5.2

Describe what occurs in each of the sections A, B, C and D.

- A
- B
- C
- D

[3]

[Total: 9]

- 6 Fig. 6.1 shows wave crests and the direction of travel for a water wave approaching a barrier in a large ripple tank.

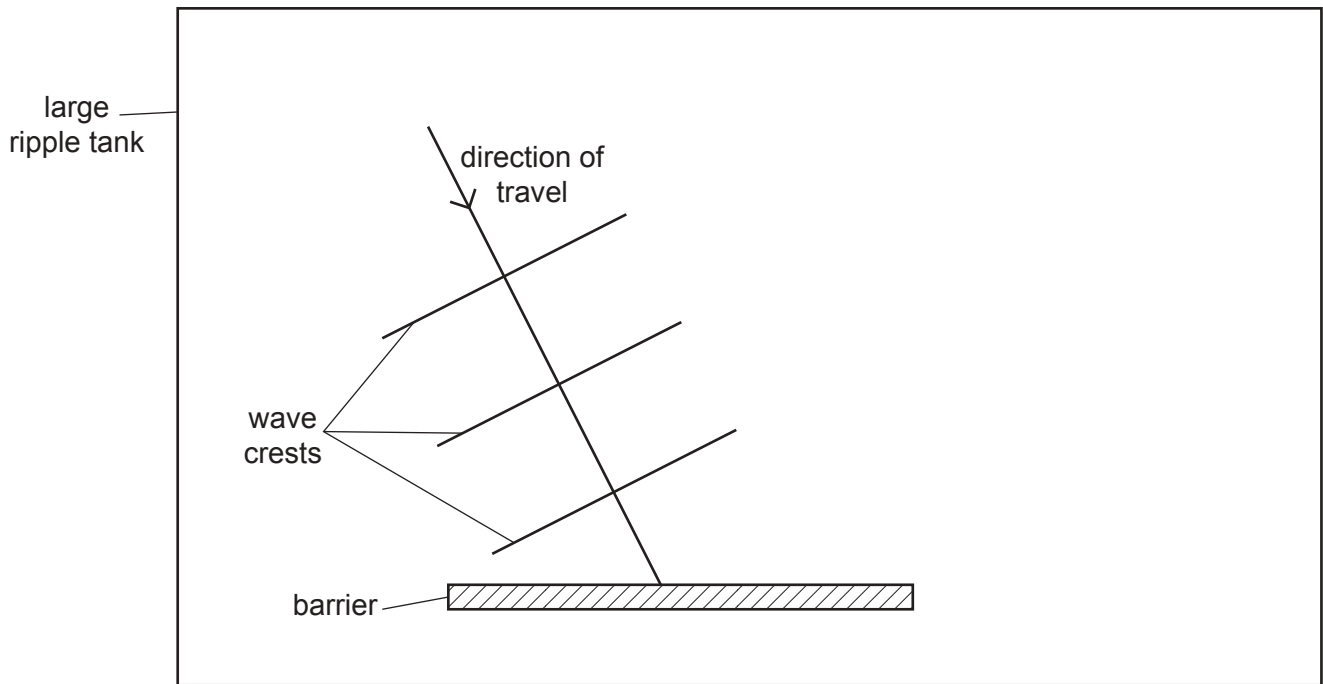

Fig. 6.1

The wavelength of the wave is 1.6 cm.

(a) On Fig. 6.1, draw:

- (i) the direction of travel of the reflected wave [1]
- (ii) **three** successive reflected wave crests. [2]

(b) Fig. 6.2 shows an identical wave approaching a barrier with a gap of 1.3 cm.

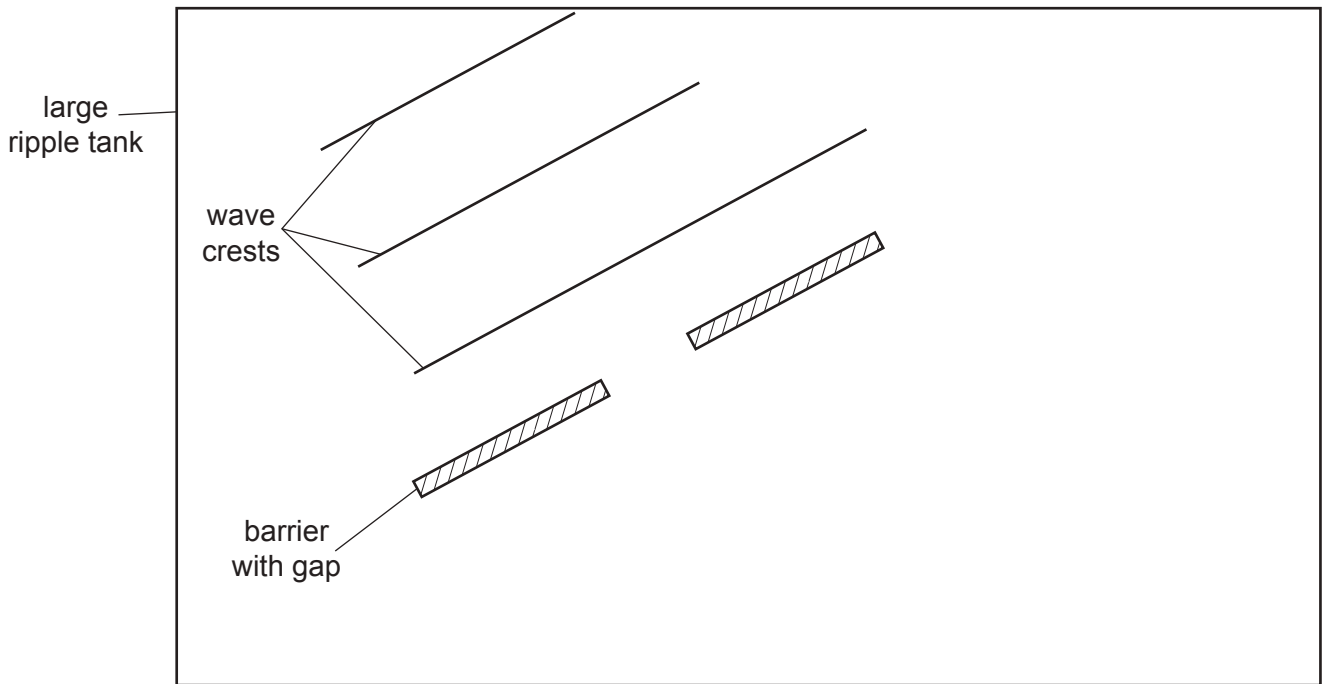

Fig. 6.2

On Fig. 6.2, draw **three** successive wave crests after they pass through the gap in the barrier. [3]

(c) The frequency of the wave is 4.0 Hz.

Calculate the speed of the wave.

speed = [2]

[Total: 8]

7 (a) State what is meant by total internal reflection.

.....
 [2]

(b) Fig. 7.1 shows a ray of light from a light source in a tank containing a liquid.

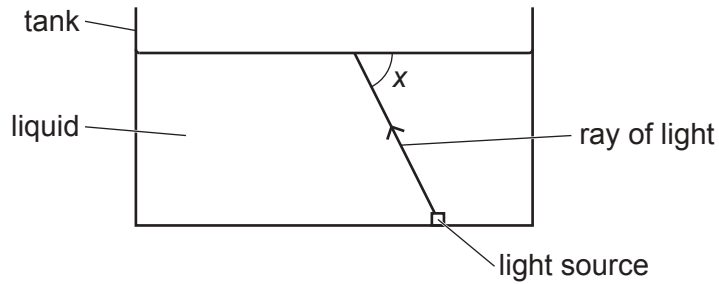

Fig. 7.1

The ray of light strikes the surface of the liquid at an angle x .

(i) The refractive index of the liquid is 1.5.

Calculate the largest value of x for which total internal reflection can occur.

$x =$ [3]

(ii) The speed of light in air is 3.0×10^8 m/s.

Calculate the speed of light in the liquid.

speed = [2]

[Total: 7]

8 Fig. 8.1 shows apparatus used to charge a metal plate by induction.

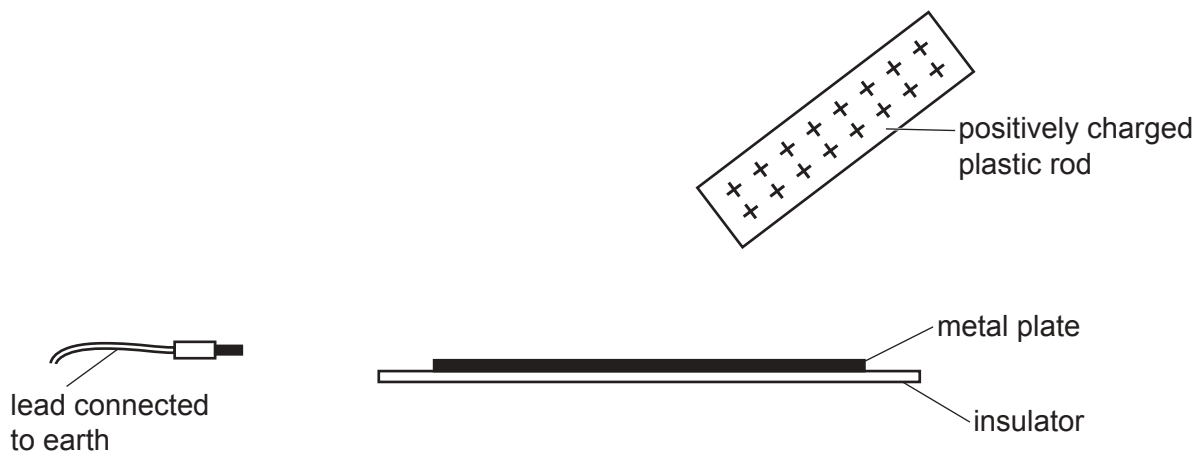

Fig. 8.1

(a) Describe and explain how the apparatus shown in Fig. 8.1 can be used to charge the metal plate.

.....

.....

.....

.....

.....

.....

.....

..... [4]

(b) Fig. 8.2 shows an electric circuit.

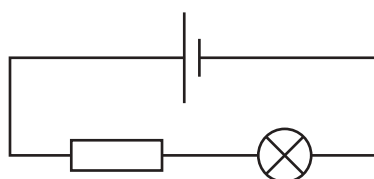

Fig. 8.2

On Fig. 8.2, draw an arrow to show the direction of flow of electrons and explain how you determined the direction.

explanation

[Total: 5]

- 9 Fig. 9.1 shows a circuit with an alternating current (a.c.) supply, a resistor and a diode.

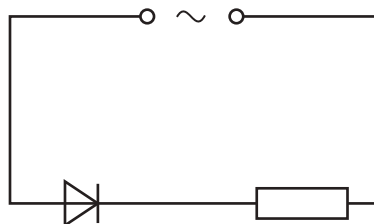

Fig. 9.1

The frequency of the power supply is 50 Hz.

- (a) Calculate the time period (time for one complete cycle) of the a.c. supply.

time = [2]

- (b) The peak potential difference (p.d.) across the resistor is 340 V.

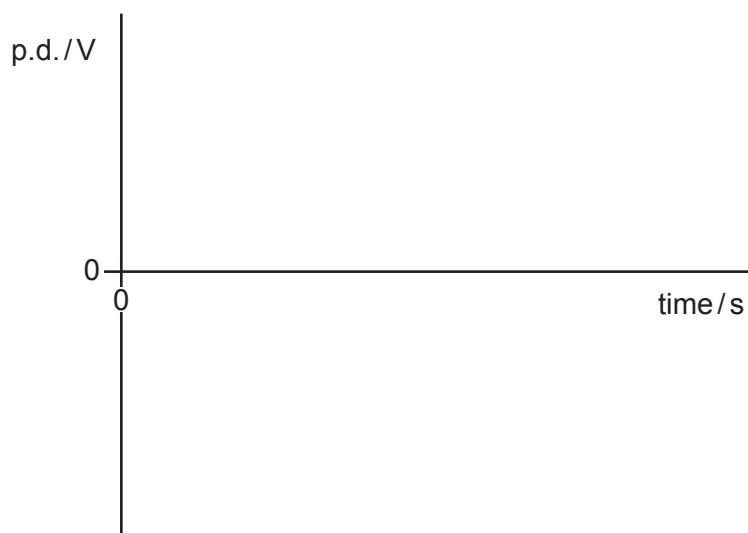

Fig. 9.2

On Fig. 9.2:

- (i) sketch a graph to show how the p.d. across the resistor varies with time for two cycles [2]
 (ii) label the p.d. axis with the value of p.d. at the peak [1]
 (iii) label the time axis with two values of time. [2]

[Total: 7]

- 10 (a) A cloud chamber can be used to detect α (alpha)-particles and β (beta)-particles. Alcohol in the cloud chamber exists as a vapour and condenses on ions produced in the air. This forms visible tracks.

Fig. 10.1 shows the tracks when a source of α -particles and β -particles is present in the cloud chamber.

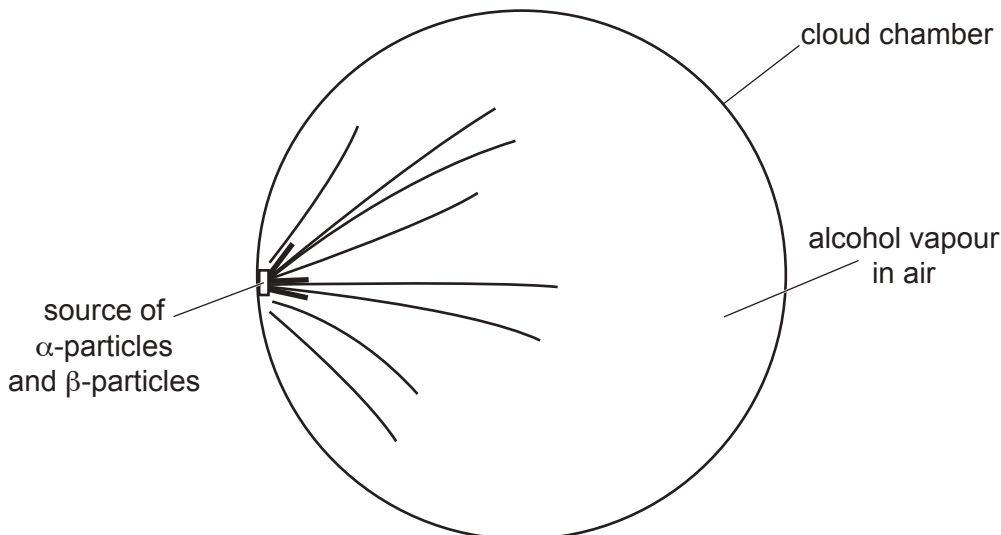

Fig. 10.1

Some of the tracks are short and thick. Other tracks are longer and thinner.

State and explain which tracks are produced by α -particles and which tracks are produced by β -particles.

α -particles

.....

β -particles

..... [3]

- (b) A radioactive isotope of sodium (Na) is used to detect leaks from water pipes. A nucleus of this isotope of sodium contains 11 protons and 13 neutrons. This nucleus decays by emitting a β -particle to form a nucleus of magnesium (Mg).

(i) Describe what is meant by an isotope.

.....

.....

..... [2]

(ii) Write down the nuclide equation for the decay of this isotope of sodium to magnesium.

[3]

(iii) This isotope of sodium has a half-life of 15 hours. The isotope of magnesium is stable and does not undergo radioactive decay.

Suggest why these properties of the isotope of sodium and the isotope of magnesium make this isotope of sodium suitable to detect leaks from water pipes.

.....
.....
..... [2]

[Total: 10]

11 (a) Fig. 11.1 shows a solenoid connected to a battery.

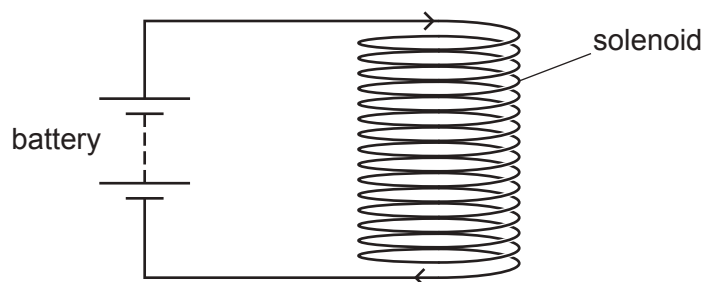

Fig. 11.1

On Fig. 11.1, draw the pattern of the magnetic field inside and around the solenoid. Indicate the direction of the magnetic field with an arrow. [3]

(b) Electrical power is transmitted at a voltage of 400 kV. A transformer reduces the voltage to 33 kV for use by heavy industry in large factories. The number of turns on the primary coil of the transformer is 11 000.

Calculate the number of turns on the secondary coil of the transformer.

number of turns = [2]

[Total: 5]

Permission to reproduce items where third-party owned material protected by copyright is included has been sought and cleared where possible. Every reasonable effort has been made by the publisher (UCLES) to trace copyright holders, but if any items requiring clearance have unwittingly been included, the publisher will be pleased to make amends at the earliest possible opportunity.

To avoid the issue of disclosure of answer-related information to candidates, all copyright acknowledgements are reproduced online in the Cambridge Assessment International Education Copyright Acknowledgements Booklet. This is produced for each series of examinations and is freely available to download at www.cambridgeinternational.org after the live examination series.

Cambridge Assessment International Education is part of Cambridge Assessment. Cambridge Assessment is the brand name of the University of Cambridge Local Examinations Syndicate (UCLES), which is a department of the University of Cambridge.