



Cambridge IGCSE™

PHYSICS

0625/22

Paper 2 Multiple Choice (Extended)

May/June 2022

45 minutes

You must answer on the multiple choice answer sheet.

You will need: Multiple choice answer sheet
Soft clean eraser
Soft pencil (type B or HB is recommended)

INSTRUCTIONS

- There are **forty** questions on this paper. Answer **all** questions.
- For each question there are four possible answers **A**, **B**, **C** and **D**. Choose the **one** you consider correct and record your choice in soft pencil on the multiple choice answer sheet.
- Follow the instructions on the multiple choice answer sheet.
- Write in soft pencil.
- Write your name, centre number and candidate number on the multiple choice answer sheet in the spaces provided unless this has been done for you.
- Do **not** use correction fluid.
- Do **not** write on any bar codes.
- You may use a calculator.
- Take the weight of 1.0 kg to be 10 N (acceleration of free fall = 10 m/s^2).

INFORMATION

- The total mark for this paper is 40.
- Each correct answer will score one mark.
- Any rough working should be done on this question paper.

This document has **20** pages. Any blank pages are indicated.



1 Very small values of which quantity are measured using a micrometer screw gauge?

- A time
- B pressure
- C moment
- D distance

2 A man stands next to a railway track.

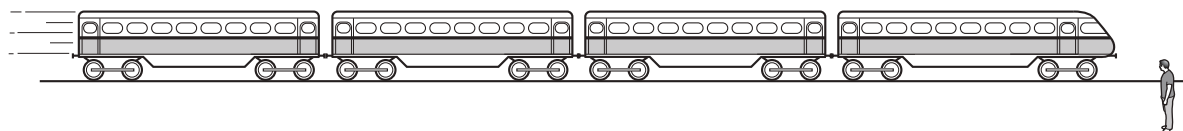

A train travelling at 40 m/s takes 2.0 s to pass the man.

What is the length of the train?

- A 20 m B 38 m C 40 m D 80 m

3 Which quantity is equal to acceleration?

- A area under a distance–time graph
- B area under a speed–time graph
- C gradient of a distance–time graph
- D gradient of a speed–time graph

4 On the Moon, all objects fall with the same acceleration.

Which statement explains this?

- A On the Moon, all objects have the same weight.
- B The Moon has a smaller gravitational field strength than the Earth.
- C The weight of an object is directly proportional to its mass.
- D The weight of an object is inversely proportional to its mass.

- 5 A measuring cylinder contains 30 cm^3 of a liquid.

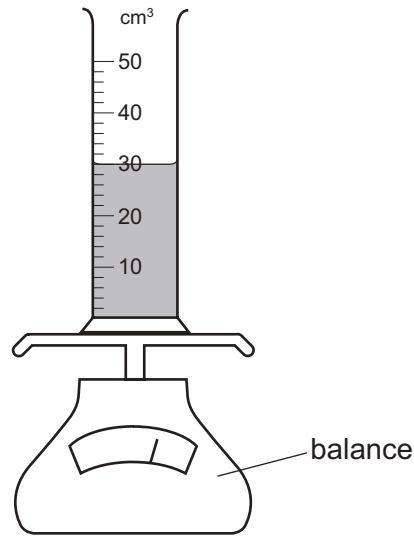

Some more of the liquid is added until the liquid level reaches the 50 cm^3 mark.

The reading on the balance increases by 30 g.

What is the density of the liquid?

- A** 0.60 g/cm^3 **B** 0.67 g/cm^3 **C** 1.5 g/cm^3 **D** 1.7 g/cm^3
- 6 An object moves at constant speed around a circular path.
- Which statement is correct?
- A** A resultant force acts on the object outwards from the centre of the circle.
- B** A resultant force acts on the object in the direction it is travelling.
- C** A resultant force acts on the object towards the centre of the circle.
- D** There is no resultant force acting on the object because it is moving at constant speed.

- 7 A beam is pivoted at one end, as shown.

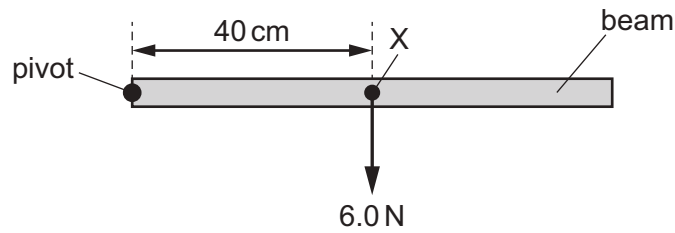

The beam weighs 6.0 N and its weight acts at a point X 40 cm from the pivot.

A force of 4.0 N is applied to the beam causing it to balance horizontally.

In which direction and where is the 4.0 N force applied?

- A vertically downwards at 20 cm to the left of X
 - B vertically downwards at 20 cm to the right of X
 - C vertically upwards at 20 cm to the left of X
 - D vertically upwards at 20 cm to the right of X
- 8 The diagram shows two forces acting at right angles to each other.

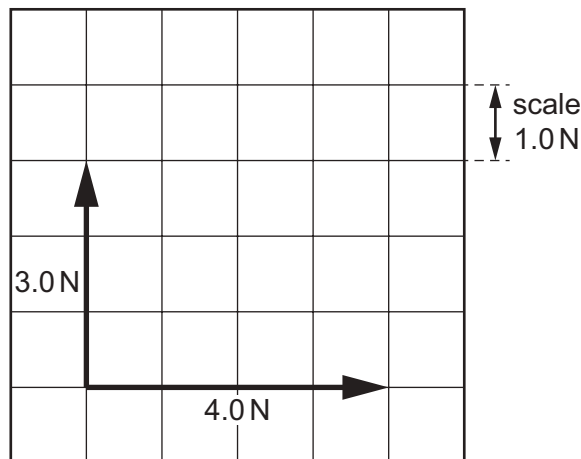

What is the resultant of the two forces?

- A 1.0 N
 - B 5.0 N
 - C 7.0 N
 - D 12.0 N
- 9 Which statement describes the impulse acting on an object?
- A Impulse is the change in kinetic energy of the object.
 - B Impulse is the change in momentum of the object.
 - C Impulse is the rate of change of force acting on the object.
 - D Impulse is the rate of change of momentum of the object.

- 10 A ball of mass 0.16 kg is moving forwards at a speed of 0.50 m/s. A second ball of mass 0.10 kg is stationary. The first ball strikes the second ball. The second ball moves forwards at a speed of 0.50 m/s.

What is the speed of the first ball after the collision?

- A 0.0 m/s B 0.19 m/s C 0.31 m/s D 0.50 m/s
- 11 A tennis ball is dropped from position 1. It falls vertically onto a hard surface at position 2.

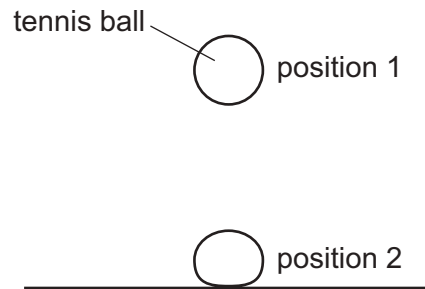

Which energy changes have taken place between position 1 and position 2?

- A gravitational potential → kinetic → chemical
B gravitational potential → kinetic → elastic (strain)
C kinetic → gravitational potential → chemical
D kinetic → gravitational potential → elastic (strain)
- 12 A boy holds onto a bar and pulls himself up until his chin is level with the bar.

He raises himself through 40 cm in 0.5 s.

The weight of the boy is 500 N.

What is the average power he produces as he raises himself?

- A 40 W B 400 W C 4000 W D 40000 W

- 13 The diagram shows a deep reservoir formed by a dam.

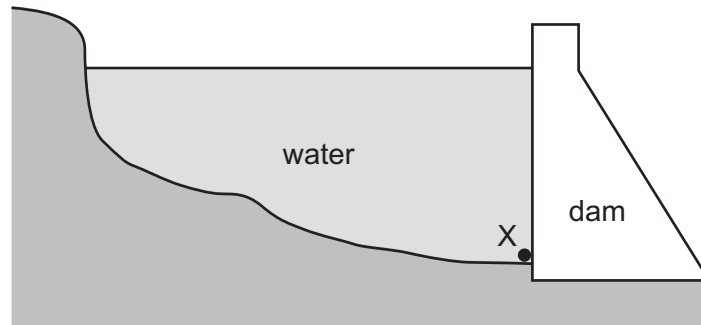

On what does the pressure at X depend?

- A the depth of the water at X
 - B the length of the reservoir
 - C the surface area of the water
 - D the thickness of the dam wall
- 14 The conditions of a sample of gas change in two stages.
- stage 1 increase of temperature at constant volume
- stage 2 increase of volume with no further change of temperature

Which row about the pressure after each stage is correct?

	stage 1 pressure compared to original pressure	stage 2 pressure compared to pressure after stage 1
A	decreases	decreases
B	decreases	increases
C	increases	decreases
D	increases	increases

- 15 Small pollen particles are suspended in water.

When viewed with a microscope, the pollen particles can be seen to be moving about irregularly.

What causes this movement?

- A The pollen particles are being bombarded by the heavier particles of the water.
- B The pollen particles are being bombarded by the lighter particles of the water.
- C The temperature of the water is higher than that of the pollen particles.
- D The temperature of the water is lower than that of the pollen particles.

- 16 The diagram shows a liquid-in-glass thermometer.

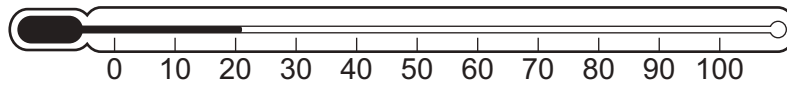

Which physical property of the thermometer is used to measure temperature?

- A expansion of glass
 - B expansion of liquid
 - C mass of glass
 - D mass of liquid
- 17 A block of lead of mass 500 g is at its melting point.
The specific latent heat of fusion of lead = 23 kJ/kg.
How much energy is required to completely melt the block?
- A 46 J B 12000 J C 46 000 J D 12000 000 J
- 18 A glass contains an iced drink on a warm and humid day. Water starts to form on the outside of the glass.

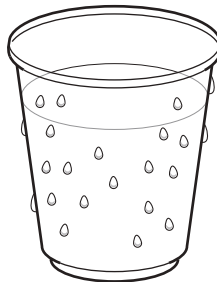

What is the name of the effect by which the water forms?

- A condensation
- B conduction
- C convection
- D evaporation

19 One end of a copper bar is heated to a high temperature.

Which mechanism is responsible for the transfer of thermal energy to the other end of the copper bar?

- A the lattice vibrations of copper ions only
- B the lattice vibrations of copper ions and the movement of high energy electrons along the bar
- C the movement of high energy copper ions along the bar
- D the movement of high energy electrons along the bar only

20 Four cubic copper containers are filled with water. The surfaces of all the containers are painted black.

Two of the containers have sides of length 20 cm and the other two containers have sides of length 40 cm.

Two of the containers contain water at 80 °C and the other two contain water at 30 °C.

Which container radiates energy at the lowest rate?

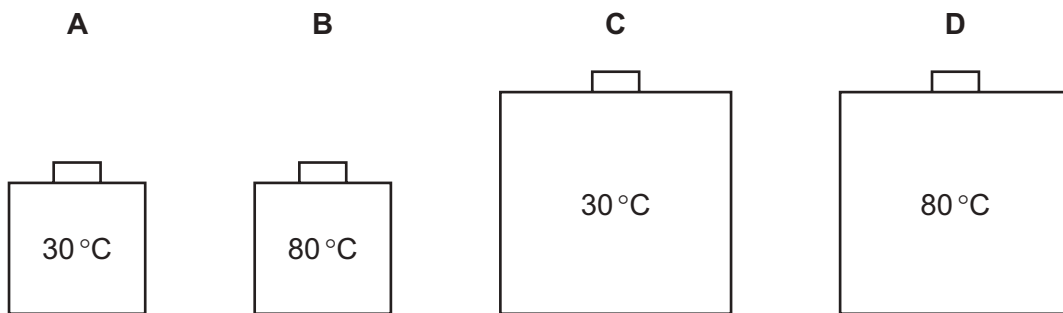

21 The diagram shows a wave.

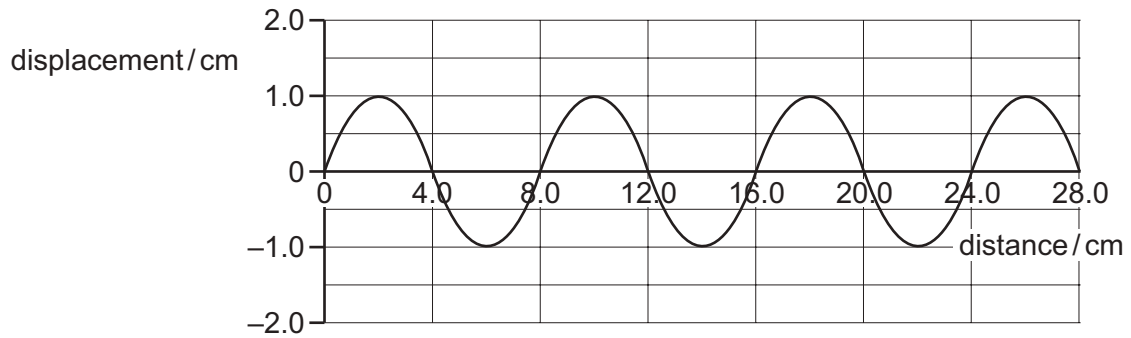

Which row is correct?

	amplitude of the wave / cm	wavelength of the wave / cm
A	1.0	4.0
B	1.0	8.0
C	2.0	4.0
D	2.0	8.0

22 The water wave shown has a frequency of 4.0 Hz.

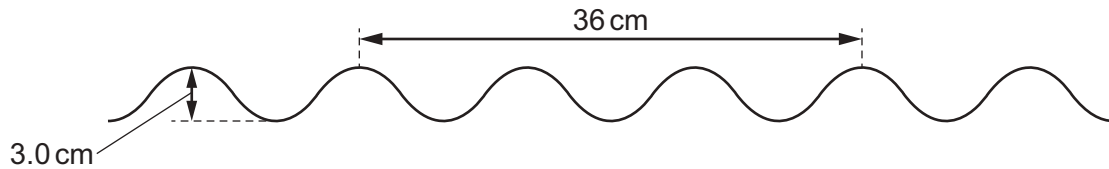

What is the speed of the wave?

- A** 3.0 cm/s **B** 12 cm/s **C** 48 cm/s **D** 72 cm/s

- 23 A student uses one eye to look at images in a plane mirror.

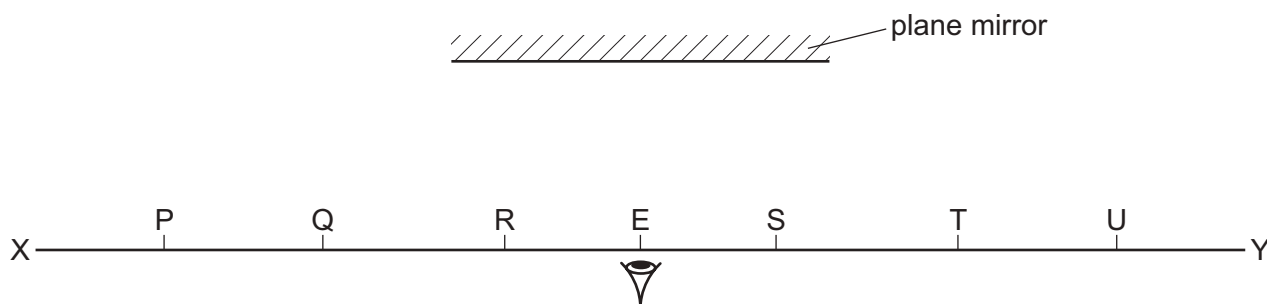

Objects are placed on the line XY.

Which objects give rise to images that can be seen by the eye at E?

- A** P, Q, R, S, T and U
B Q, R, S and T only
C P and U only
D R and S only
- 24 An object is placed in front of a converging lens of focal length 15 cm.

Which row describes the image of the object?

	distance of object from lens / cm	nature of the image
A	40	real, upright, diminished
B	30	virtual, inverted, enlarged
C	20	real, inverted, diminished
D	10	virtual, upright, enlarged

- 25 The speed of light in air is 3.0×10^8 m/s.

The critical angle for light in a transparent plastic material placed in air is 37° .

What is the speed of light in the plastic material?

- A** 1.8×10^8 m/s
B 2.4×10^8 m/s
C 3.8×10^8 m/s
D 5.0×10^8 m/s

- 26 Which type of waves are produced by a television remote controller?
- A infrared waves
 - B radio waves
 - C ultraviolet waves
 - D visible light
- 27 Which statement correctly compares radio waves and X-rays?
- A Radio waves have a longer wavelength and a greater speed in a vacuum.
 - B Radio waves have a longer wavelength and the same speed in a vacuum.
 - C Radio waves have a shorter wavelength and a greater speed in a vacuum.
 - D Radio waves have a shorter wavelength and the same speed in a vacuum.

- 28 The diagram shows the magnetic fields around three objects, P, Q and R, placed close to each other.

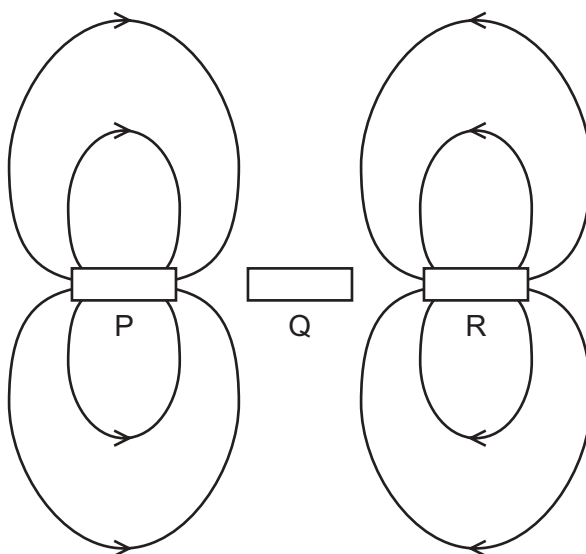

Which row shows the nature of each of the objects?

	P	Q	R
A	permanent magnet N S	copper rod	permanent magnet N S
B	permanent magnet N S	copper rod	permanent magnet S N
C	permanent magnet N S	iron rod	permanent magnet N S
D	permanent magnet N S	iron rod	permanent magnet S N

- 29 A negatively charged rod is brought near to an uncharged metal sphere that is placed on an insulating stand.

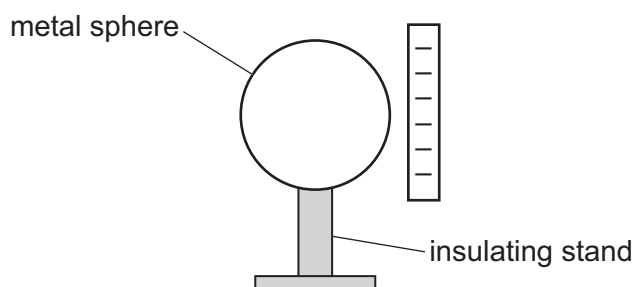

Which diagram shows the distribution of charges on the sphere?

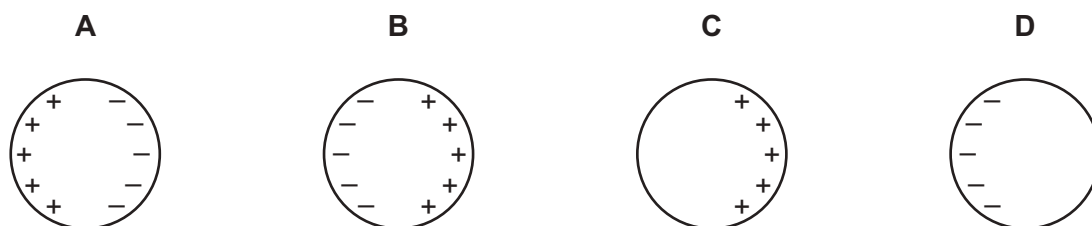

- 30 A resistor has a potential difference (p.d.) of 12 V across it and a current of 0.60 A in it.

What is the resistance of the resistor?

- A 0.050 Ω B 2.0 Ω C 7.2 Ω D 20 Ω
- 31 There is a current I in a resistor of resistance R for a time t . The potential difference (p.d.) across the resistor is V .

Which equation gives the power P dissipated in the resistor?

- A $P = IR$ B $P = It$ C $P = IV$ D $P = \frac{IV}{t}$

32 The four circuits shown each contain four diodes.

In which circuit is the direction of the current in the resistor always from the red terminal to the black terminal?

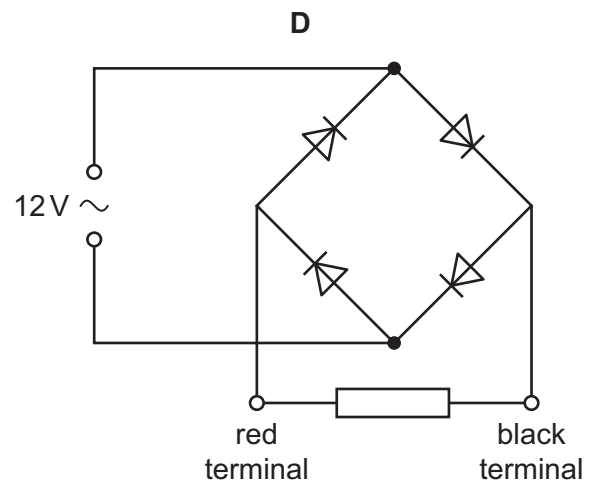
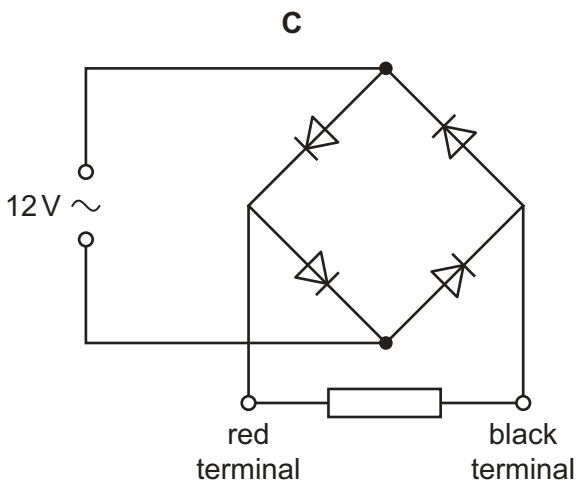
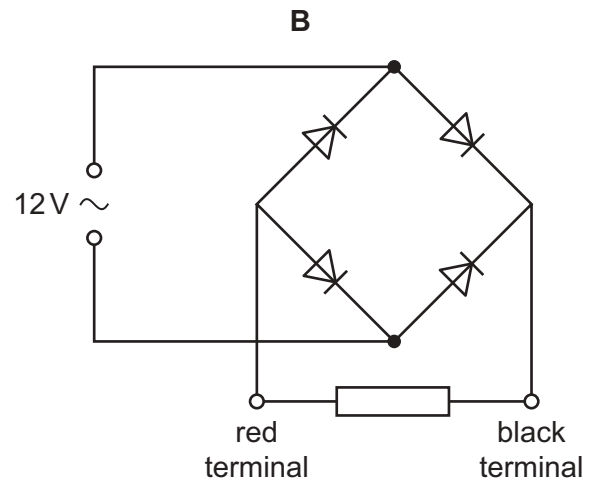
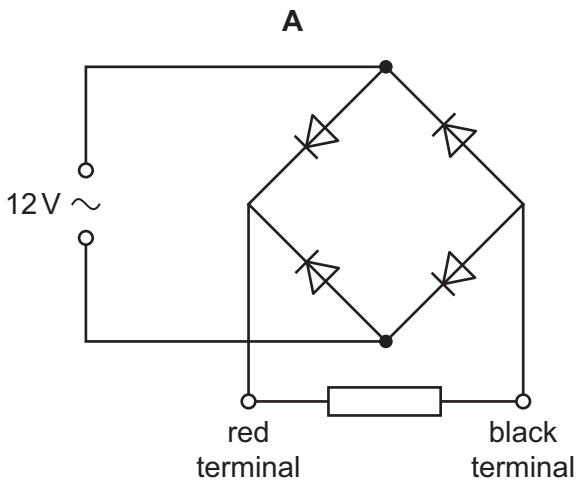

- 33 The diagram shows a battery connected to a potential divider and to two lamps, P and Q.

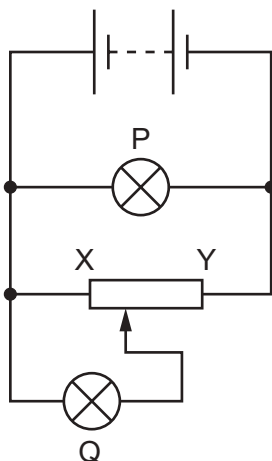

The slider on the potential divider is moved from end X to end Y of the resistor.

Which row shows the effect on the brightness of each lamp?

	brightness of P	brightness of Q
A	brighter	brighter
B	brighter	dimmer
C	unchanged	brighter
D	unchanged	dimmer

- 34 What is the truth table for the logic gate shown by the symbol?



A			B			C			D		
X	Y	OUT	X	Y	OUT	X	Y	OUT	X	Y	OUT
0	0	0	0	0	0	0	0	1	0	0	1
0	1	0	0	1	1	0	1	0	0	1	1
1	0	0	1	0	1	1	0	0	1	0	1
1	1	1	1	1	1	1	1	0	1	1	0

35 A coil XY is wound around a cardboard tube.

When the S pole of a magnet is pushed into the coil XY, the galvanometer deflects to the left.

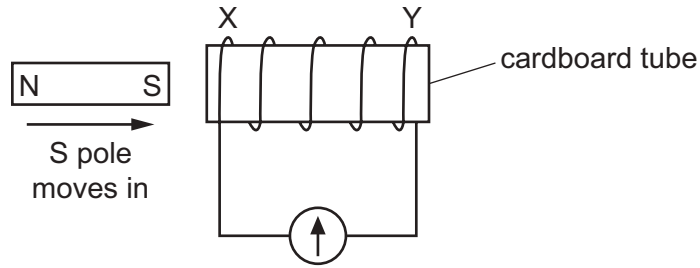

What other movement of the magnet will produce a deflection to the left?

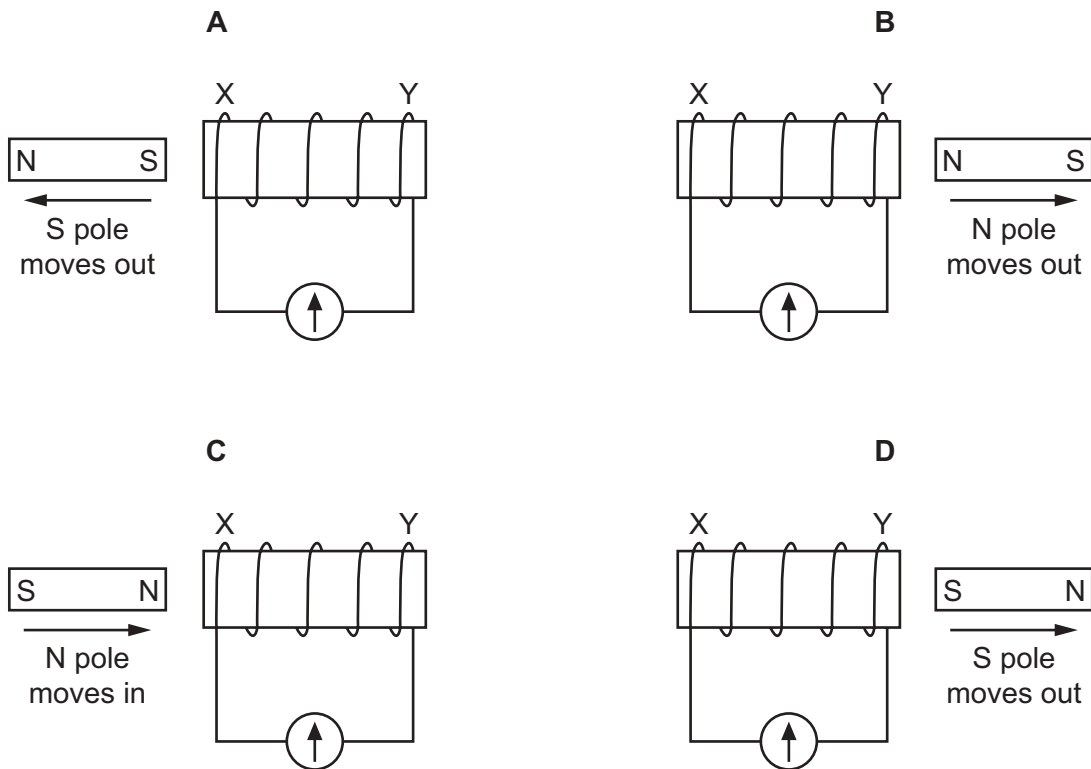

36 Which transformer can change a 240 V a.c. input into a 15 V a.c. output?

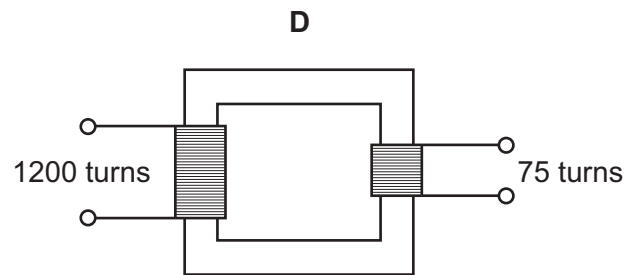
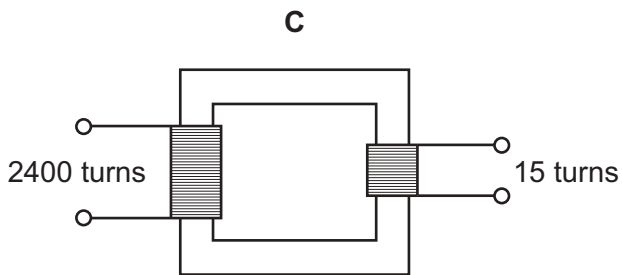
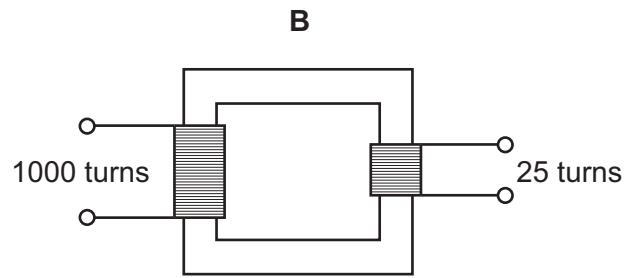
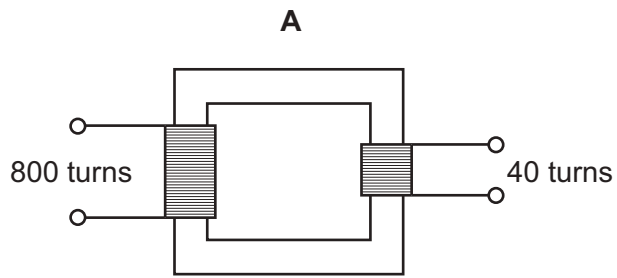

37 The diagram shows a current-carrying wire in a magnetic field.

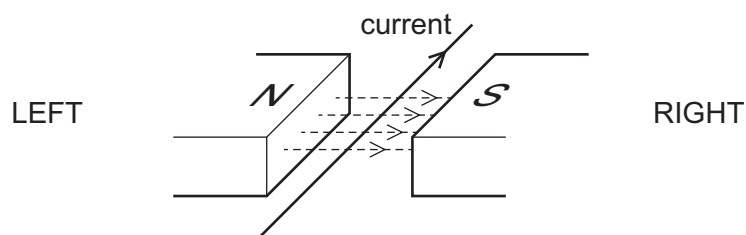

In which direction is the force acting on the wire?

- A** towards the bottom of the page
- B** to the left
- C** to the right
- D** towards the top of the page

- 38 A scientist was asked to separate the following equations into two categories: nuclear fission and nuclear fusion.

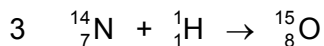
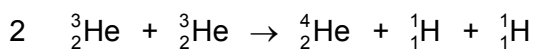
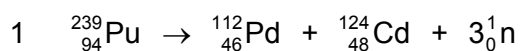

Which equations show nuclear fission?

- A** 1 and 2 **B** 1 and 3 **C** 1 and 4 **D** 2 and 4
- 39 Which radioactive source is used in a smoke alarm system and what is the reason for this?

	source	reason
A	α	causes least ionisation of air
B	α	causes most ionisation of air
C	γ	causes least ionisation of air
D	γ	causes most ionisation of air

- 40 A beam of α -particles and β -particles is incident at right angles to an electric field.

Which statement about the deflection of the particles in the field is correct?

- A** α -particles deflect, but β -particles do not deflect.
B α -particles deflect in the opposite direction to β -particles.
C β -particles deflect, but α -particles do not deflect.
D Both α -particles and β -particles deflect in the same direction.